

Three Phase
4 Wire Wye
120/240 Transformers

Available Voltage:
120V Line to Neutral
208V Line to Line

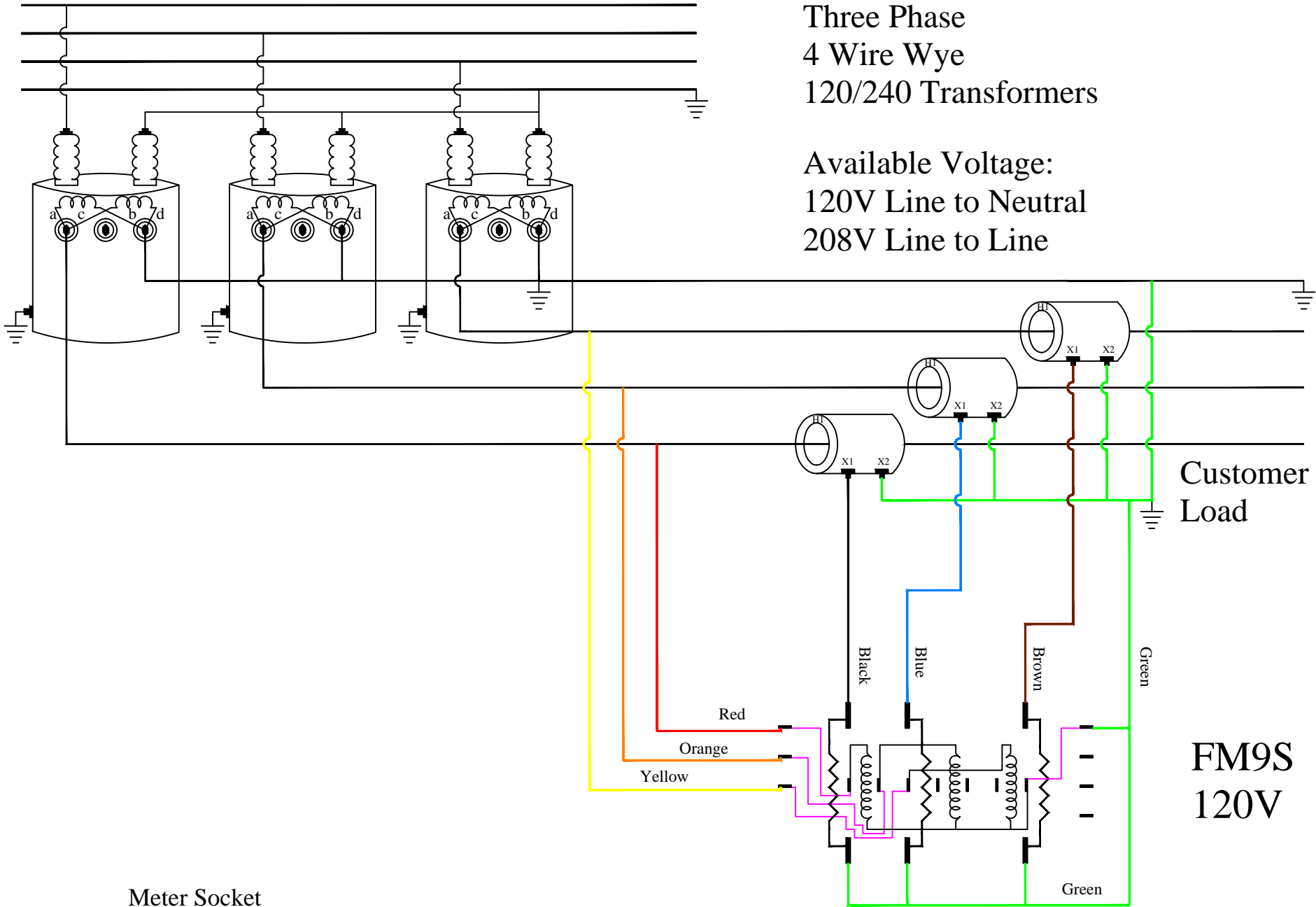

Meter Socket
Must Be Grounded

Customer
Load

FM9S
120V